

# Data Sheet



Article number: 20927344M430B

Description: E+G Clamping lever GN 927.3-44-M4-30-B  
Male thread

## Measures

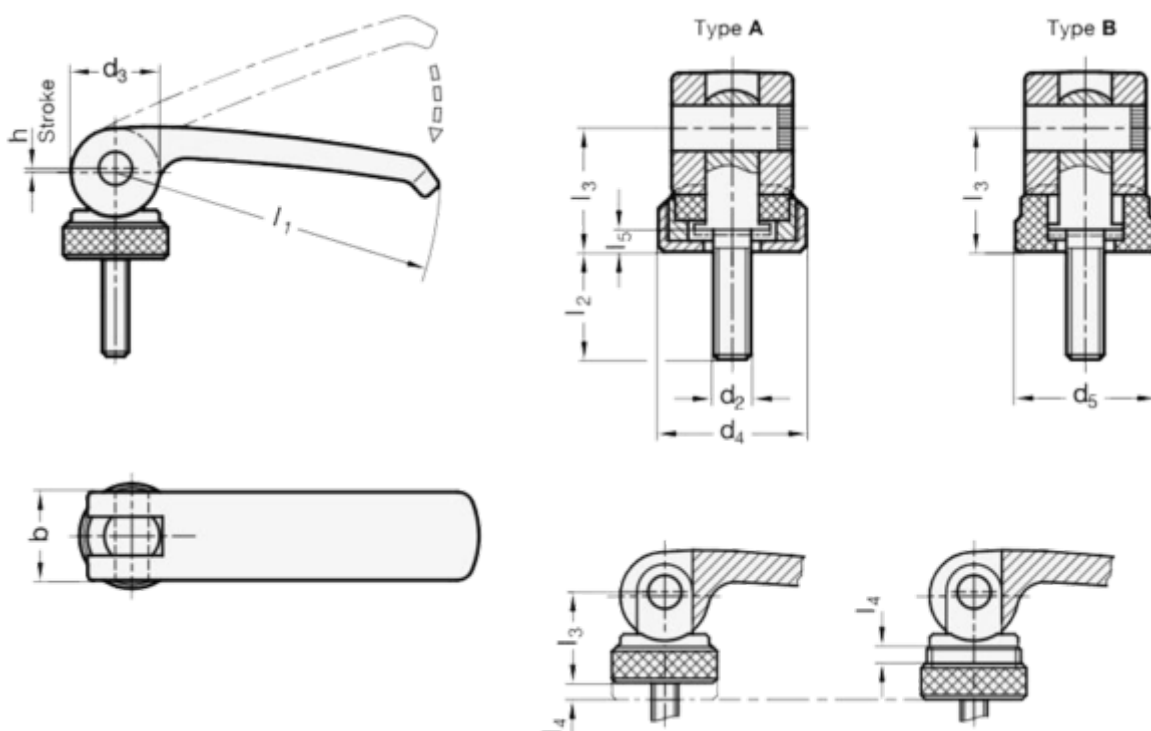

b = 12  
d2 = M4  
d4 =  
d5 = 14  
l1 = 44  
l2 = 30